

DPMP

Digital Multi-Range 3Ø Voltage Monitor



Voltage Ranges:

- 115 to 277VAC, 1Ø
- 200 to 600VAC, 3Ø

Digital Display:

- Line Voltages
- Frequency
- Imbalance %
- Output Relay Status
- Last 4 Faults
- Set-Up Menus

SPDT Contacts

Operation

The DPMP is a Digital Phase Monitor that will monitor line voltages from 115VAC up to 600VAC. Actual line voltages and set-up parameters are set via the digital display. The supply voltage must be available during operation.

With the supply voltage active, you can set-up all of the DPMP's settings without the line voltage connected.

When the DPMP is connected to the line voltage, it will monitor the line and if everything is within the set-up parameters, the output contacts will be activated. If the line voltages fall outside the set-up parameters, the output relay will be de-energized after the trip delay.

Once the line voltages recover, the DPMP will re-energize the output relay after the re-start time delay (manual to 4 minutes).

All settings and the last 4 faults are retained, even if there is a complete loss of power.

Specifications

Electrical

Line Voltage: 115 to 277VAC, 1Ø
200 to 600VAC, 3Ø

Supply Voltage:
12VDC, 24VDC, 24VAC, 120VAC & 240VAC, 1Ø

Frequency: 50/60Hz

Display:
16 Character, 2 line, LCD back lighting

Adjustments:

Membrane Buttons & Display

Nominal Voltage: Adj. 200 to 600VAC

Over/Under Voltage: Adj. 7% to 15%

Phase Imbalance: 3% to 10%

Phase Rotation: A - B - C

Delays:

Trip Delay: Adj. 2 sec. to 10 sec.

Re-Start Delay: Adj. Manual Reset to 4 min.

Power Consumption: 2.1VA

Output Rating @ 25°C:

10 Amps @ 120VAC

6 Amps @ 277VAC

1/8 HP @ 120/277VAC

5 Amps @ 30VDC

Physical

Mounting: Panel Mounting

4 Inserts for 2 Mounting DIM,

Torq Mounting Screws to 18in/lb.

Termination:

5mm Pluggable Block

Packaging: Gasketed Bezel

Weight: 1 Pound

Ambient Temperatures

Operating:

B - Terminal Blocks -40°C** to 59°C

**Display & membrane may not function below -20°C.

Storage: -40°C to 85°C

Ordering Information

DPMP - 24A - B -

R-K Model

Supply Voltage

12D - 12VDC

24D - 24VDC

24A - 24VAC

120A - 120VAC

240A - 240VAC

Special

XXXX - Special

Termination

B - Terminal Blocks

Dimensions

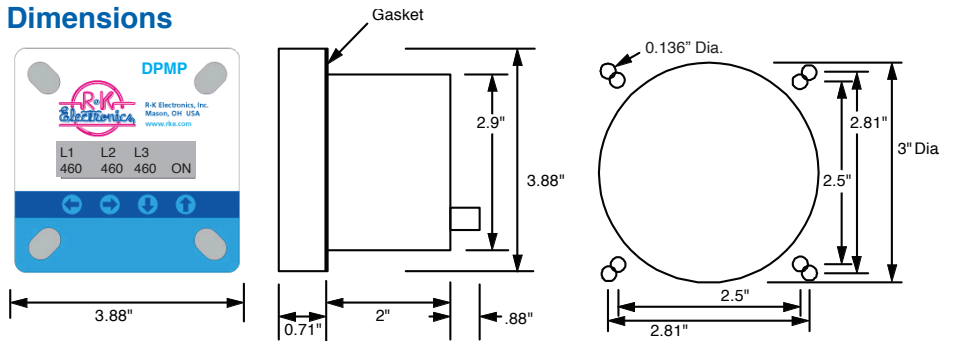

Connections

